



# MF 6S

135–200 HP

## A NEW ERA

FOR STRAIGHTFORWARD AND DEPENDABLE  
CONCENTRATED PERFORMANCE



MASSEY FERGUSON

BORN TO **FARM**



**MF 6S**  
**CONTINUING A NEW ERA**  
 for Straightforward and Dependable tractors

“Massey Ferguson takes pride in developing straightforward, dependable and smart machines to help farmers meet the daily challenges they encounter and to ensure they can get their work done easily and efficiently.”

Thierry Lhotte  
 Vice-President & Managing Director Massey Ferguson Europe & Middle East

The MF 6S Series offers enhanced user experience to the 135 hp to 200 hp sector blending comfort, connectivity and smart farming.

To meet the increasing demands of modern, sustainable farming Massey Ferguson combines smart machines with a comprehensive range of fully connected digital services to help you manage your business more efficiently. This personalised experience starts when you first consider the purchase and lasts through the machine's entire, dependable lifetime.

The MF 6S is a fully connected tractor. This advanced connectivity ensures operators are constantly in

contact with their farm, fleet, Massey Ferguson dealer and advisors – keeping them in touch with those that matter.

This connectivity opens up a whole range of innovative digital services tailored to your needs and developed to keep your tractor running and protecting your profitability.

You can rely on the MF 6S Series to deliver the power, efficiency and productivity you need to get your work done easily. At the same time it provides low operating costs to benefit from the best return on your investment.



# MF 6S

## STRONG, AGILE AND SMART

With the MF 6S Series, Massey Ferguson extends its 'New Era' of enhanced user experience, connectivity and smart farming from the award-winning new MF 8S to the important 135 hp to 200 hp sector.

As well as following the new, modern family style, these new tractors introduce significantly higher levels of comfort and ergonomics.

Compact and powerful, these lightweight, manoeuvrable tractors are supreme all-rounders, combining the power, performance and advanced control to excel in field operations, with the agility and unrivalled specifications for loader operations.

Powered by lively four cylinder engines, these compact, agile tractors offer an outstanding power-to-weight ratio, providing the equivalent draft, torque and power of a larger six cylinder.



### MAKE THE TRACTOR YOUR OWN

10

08

#### THE CAB COMPACT AND CONVENIENT

### MADE FOR MANOEUVRABILITY & TRACTION

34

20

#### SMART FARMING & CONNECTIVITY

28

#### HIGH EFFICIENCY TRANSMISSIONS

Your MF 6S at a Glance.....	6
Live for Comfort – The Cab environment.....	8
The Essential version.....	14
The Efficient version.....	16
The Exclusive version.....	18
Made for Smart Farming & Connectivity.....	20
Made for Performance – The Engine.....	26
Dyna-6 Transmission.....	30
Dyna-VT Transmission.....	32
Manoeuvrability & Traction.....	34
Powerful Hydraulic Muscle – Hydraulics and PTO.....	40
Loaders.....	42
Made to Maximise Uptime – A new Era of services & Customer support.....	44
Make the MF 6S as individual as your farm – Options & Specifications.....	50



## YOUR MF 6S AT A GLANCE

Your versatile MF 6S is specifically designed to deliver the high performance to excel in a wide range of applications – with the power and traction for field work, combined with the manoeuvrability and agility for transport, loading and yard operations.

Powerful all-rounders, they are perfectly specified to suit all users – from contractors and arable farms to large livestock operations.

### WITH FIVE MODELS TO CHOOSE FROM THE MF 6S SERIES IS ALWAYS THE BEST CHOICE

	MF 6S.135	MF 6S.145	MF 6S.155	MF 6S.165	MF 6S.180
Engine	AGCO Power – Stage V – All-in-One technology				
Engine capacity	4 cylinder, 4.9 litre				
Transmission	Dyna-6 or Dyna-VT				
Max power @ 1,950 rpm (hp)	135	145	155	165	180
Max power with EPM (hp)	150	160	175	185	200
Max torque @ 1,500 rpm (Nm)	648	691	745	790	800
Max torque @ 1,500 rpm with EPM (Nm)	650	700	750	800	840

#### Enjoy space, comfort, convenience and connectivity

▶ The MF 6S cab keeps operators fresh and comfortable during long working days. It combines excellent all-round visibility with easy to use controls. It is also quieter, with noise levels of just 70 dBA. Further comfort comes from the cab suspension and suspended front-axle. The new armrest provides best in class controls and ergonomics

#### Low operating costs

- ▶ The 'All-in-One' Stage V SCR system cuts costs of operations and contributes to improved visibility
- ▶ 600 hr engine service intervals - more work, less downtime
- ▶ Easy access for daily maintenance
- ▶ MF Care Repair and maintenance contract schemes

#### Designed around reliability

- ▶ Dyna-6 Super-Eco transmission. More productivity from less fuel!
- ▶ Dyna-VT transmission. Precise, smooth and easy to use
- ▶ Power Control shuttle lever - up to 8 functions in one

#### Agility and traction

- ▶ More traction-less soil compaction thanks to VF650/60R42 rear tyres
- ▶ 2.67 m wheelbase offering traction and stability
- ▶ 4.75 m turning radius unrivalled manoeuvrability

Straightforward, smart, sustainable farming technologies. Datatronic 5 and optional Fieldstar 5 terminal provide the latest user friendly precision farming package

- ▶ 9" touch screen terminal created to provide a more intuitive and precise farming experience
- ▶ MF Guide solutions provide economy by reducing overlaps
- ▶ MF Section and Rate Control allows you to adjust the application rate on the go, whilst automatically minimising overlap, skips and wasted product
- ▶ MF TaskDoc Pro creates and sends securely detailed records of jobs to the office and preferred partners through the secured Agrirouter cloud
- ▶ MF Connect telemetry enables remote and near real time monitoring and decision making, improving efficiency and maximising uptime

#### Performance where it matters

- ▶ Up to 9,600 kg rear linkage capacity
- ▶ Up to 190 l/min maximum hydraulic flow
- ▶ Increased gross vehicle weight up to 12,500 kg

#### Keep working in comfort

- ▶ Active mechanical cab suspension combines comfort with simplicity
- ▶ Up to 16 LED work lights

## VIRTUAL REALITY



### USE YOUR SMART PHONE TO STEP INSIDE THE MF 6S



- ◀ STEP 1  
Use a QR code reader app. Download it for free from App Store or the Google Play Store.



- ◀ STEP 2  
Open the app and scan this QR code...



- ◀ STEP 3  
...and step inside your Massey Ferguson tractor.

Live the eXperience in 2D, moving your smartphone around in all directions or using your fingers.



- ◀ STEP 4  
Live the full VR 3D Experience by clicking on the dedicated icon and use in combination with a pair of VR glasses.



LIVE FOR  
**COMFORT**

## THE CAB COMPACT AND CONVENIENT

MF 6S operators will remain fresh and alert, cosseted in the comfortable and quiet (only 70 dBA) workplace, with conveniently located, easy to use controls. Contented operators concentrate better on their work, improving quality, safety and productivity.



## THE CAB

In the spacious and quiet MF 6S cab you are greeted by a smart new steering wheel, its modern Sabre signature design, courtesy lighting and high quality materials. All controls fall easily to hand on the new armrest, which houses the MultiPad lever. This puts operation of the main functions at your fingertips, with a new roller switch to quickly and easily manage the transmission settings and driving modes. With four levels of specification to choose from, you can select the right level of comfort, control and automation you need to really make the tractor your own.



### 4 SPECIFICATIONS

Essential, Panoramic, Efficient, Exclusive –  
to suit all needs and applications



### VISIBILITY

for enhanced efficiency, comfort and safety



### EASY TO USE

with a logical layout and new armrest offering  
comprehensive control

# WHATEVER YOU DO, MAKE THE TRACTOR YOUR OWN

The MF 6S new cab design offers unrivalled comfort, visibility and ease of use. Equipped to a high specification as standard, the cab makes your working life easier and more productive.

No farm or operator is the same, so Massey Ferguson offers an extensive range of output and comfort enhancing equipment, so you can make your MF 6S your own.



## MADE FOR **COMFORT**

SMALL DETAILS ADD UP TO HIGHER OUTPUT  
DURING LONG WORKING DAYS.



### ADVANCED DASHBOARD WITH PERFORMANCE MONITOR

Operators will appreciate the slim dashboard, which clearly displays operating data on its 70mm x 52mm, colour 'Set up and Information Screen'.



**EASY AND SECURE ACCESS.**  
Large wide door, steps, rails and tiltable steering column provide best-in-class accessibility to the cab.



**ALWAYS CONNECTED** - Two USB ports as standard and adjustable phone and tablet holder available through AGCO Parts.



**BLUETOOTH RDS/MP3 RADIO** is fitted as standard allowing hands-free calls. Optional phone and data radio controls through the Datatronic 5.

# MADE FOR COMFORT

**TAILOR THE ROOF TO FIT**  
A choice of three roof types allows you to tailor your MF 6S to offer improved visibility for loader work or to increase natural ventilation: you can choose between Standard roof, Standard roof with hatch and Visio roof, ideal for loader applications.



**TELESCOPIC WIDE-ANGLE WING MIRRORS** provide a great view behind, improving visibility and increasing safety.



The outstandingly bright **16 LED LIGHT OPTION** turns night into day, increasing visibility and safety and helping you to keep going to get the job done.



**CAB SUSPENSION** with a choice of two cab suspensions: mechanical, or optional adjustable active mechanical. Operators can be sure they will always be working in utmost comfort, protected from jars and bumps.

**NOW PLEASE TAKE YOUR SEAT AND ENJOY YOUR COMFORTABLE WORKING DAY** ▶

Massey Ferguson offers the best-in class seat depending on models and options providing outstanding comfort.



**HEADLAND MANAGEMENT** is available via the Datatronic 5 on the Exclusive version (optional on Efficient version)...



...and controls are easily accessible on the armrest.



**ESSENTIAL VERSION**  
Standard air suspended, swivel seat, with headrest, longitudinal shock absorber and mechanical lumbar adjustment.



**EFFICIENT VERSION**  
Standard automatic air suspended, swivel seat, with headrest, longitudinal shock absorber and mechanical lumbar adjustment.



**EXCLUSIVE VERSION**  
Standard automatic air suspended, swivel seat, with headrest, longitudinal shock absorber, heated and pneumatic lumbar.



**OPTIONAL ON EFFICIENT AND EXCLUSIVE VERSIONS\***  
New automatic air suspended, swivel seat, with two heating levels, pneumatic lumbar, longitudinal & lateral shock absorber, dual motion backrest and DDS.

\*Not compatible with Visio roof

# ESSENTIAL VERSION

## LOGICAL, STRAIGHTFORWARD OPERATION

Essential is the entry-level package for the MF 6S Series, but is still equipped with high standard specifications.

It includes all the key elements you would expect from your tractor, with a blend of simplicity, automation and ease of use to suit a wide range of applications and operations.

	COMFORT & SAFETY	EFFICIENCY	CONNECTIVITY
<b>STANDARD</b>	<ul style="list-style-type: none"> <li>Air conditioning with manual adjustment</li> <li>Telescopic, wide-angle wing mirrors</li> <li>Radio, aerial and speakers</li> <li>Standard air-suspended seat</li> </ul>	<ul style="list-style-type: none"> <li>Control Centre with T-lever transmission control</li> <li>Dyna-6 Super-Eco - 40km/h with standard Automatic mode</li> <li>Brake-to-Neutral disengages drive with braking</li> <li>Mechanical control of spool valves</li> <li>Engine speed memory</li> </ul>	
<b>OPTION</b>	<ul style="list-style-type: none"> <li>Mechanical cab suspension</li> <li>Front axle suspension</li> <li>Panoramic cab with polycarbonate right-hand side window</li> <li>Automatic air-suspended seat</li> </ul>	<ul style="list-style-type: none"> <li>Integrated Front Linkage System and PTO</li> <li>1,000 rpm Eco rear PTO</li> <li>Dyna-6 50 km/h* Super-Eco transmission with Super Creeper (option)</li> <li>Loader-ready from factory with Multifunction mechanical joystick</li> <li>Closed-centre load-sensing hydraulics</li> </ul>	<ul style="list-style-type: none"> <li>Fieldstar 5 terminal ISOBUS</li> <li>MF Guide system with Advanced guidelines</li> <li>MF Section &amp; Rate Control</li> <li>MF TaskDoc &amp; TaskDoc Pro recording all job's data exchange</li> <li>MF Connect Telemetry</li> </ul>

\* Depending on market/legislation



### MECHANICAL MULTIFUNCTION LOADER JOYSTICK MAIN FUNCTIONS

- A Lift
- B Lower
- C Fill
- D Dump

### COMBINED FUNCTIONS

- A/C Lift and fill
- A/D Lift and dump
- B/C Lower and fill
- B/D Lower and dump-bucket adjustment to horizontal position

# THE ESSENTIAL PANORAMIC CAB OPTION



The MF 6S Series Panoramic cab offers unobstructed visibility to the right hand side for safe and efficient operation of side-mounted equipment. The wide, one-piece polycarbonate screen is extremely tough and protects operators from flying debris.

A special anti-scratch coating and dedicated wash/wipe system maintains great visibility in all conditions. For local authority and highway maintenance operations the cab can be equipped with fixing brackets and wiring for hazard warning lights and signs.

This cab option will allow a farmer/contractor to diversify his business into intensive roadside maintenance and/or contracting for local authorities.



- Light controls
- PTO Speed
- Rear linkage controls
- Safety light
- Ignition key
- Diff lock auto/manual
- 4WD auto/manual
- Side lights/low beam lamps
- Suspended front axle
- Brake to Neutral
- Mechanical hydraulic lever
- Gear Selection lever
- Hand throttle
- Rear linkage controls & depth wheel
- Rear and Front PTO Controls



# EFFICIENT VERSION

## BOOST YOUR PRODUCTIVITY

Efficient is the medium specification package for the MF 6S Series, developed to help you work smarter and in more comfort.

Dedicated to delivering increased efficiency thanks to its key features, the Efficient package enables you to work faster, to a higher standard, with more accuracy, together with high levels of comfort, ergonomics and reliability. Stay in control of the most technologically advanced and demanding implements to take advantage of their increased productivity.



Forward control  
 Customisable Functions  
 Reverse control  
 Proportional spool valve control  
 Fourth hydraulic function  
 Increase or decrease speed

### EFFICIENT ELECTRO HYDRAULIC MULTIFUNCTION JOYSTICK

- A Lift front linkage or rear valve control +
- B Lower front linkage or rear valve control -
- C Front or rear valve control +
- D Front or rear valve control -

#### COMFORT & SAFETY

##### STANDARD

- Front axle suspension
- Mechanical cab suspension
- Air Conditioning with manual adjustment
- Telescopic, wide-angle wing mirrors
- Seat-mounted armrest with Multipad controller
- Radio/ CD / MP3 Front Aux-in / Bluetooth with microphone and controls in armrest
- Automatic air-suspended seat
- 2 USB ports

##### OPTION

- Mechanical active cab suspension
- Automatic Air Conditioning
- 16 LED working Lights
- SpeedSteer
- Heated, electric adjust mirrors
- Automatic air suspended, swivel seat, with lateral suspension

#### EFFICIENCY

- Dyna-6 Super-Eco with Automatic mode or Dyna-VT 40km/h Eco transmissions
- Cruise control and Brake-to-Neutral
- 110 litre/min closed-centre load sensing hydraulics
- Electrical and mechanical spool valves
- Engine speed memory

#### CONNECTIVITY

- Datatronic 5 9" touchscreen with new interface for radio, phone and all tractor functions & technology
- Fieldstar 5 terminal
- ISOBUS
- MF Guide system with Advanced guidelines
- MF Section & Rate Control
- MF TaskDoc & TaskDoc Pro recording all job's data exchange
- MF Connect Telemetry



Datatronic 5, 9" terminal  
 Electrical PTO speed selection  
 Electronic rear linkage adjustment  
 Multifunction Hydraulic Joystick  
 Hand throttle  
 PTO activation  
 Four spool valves can be specified as standard

\* Depending on market/legislation

# EXCLUSIVE VERSION

## THE ULTIMATE EXPRESSION OF INNOVATION

Exclusive is a combination of high-spec versatility and refinement dedicated to operators looking for a tractor with advanced features and functions in terms of ergonomics, comfort, automation, smart farming capacities and full connectivity.

This version is aimed at more intensive, large scale operators looking for more advanced features that will ensure cost-effective benefits for their business. The Exclusive armrest comes with numerous benefits including comfort and convenience when operating multiple, frequently-used controls.

Exclusive also adds the Datatronic 5 as standard. Use the 9" touchscreen terminal to manage tractor functions, ISOBUS capability to simplify implement operations and use of MF Smart Farming solutions.

Using the Exclusive package, operate the most technologically advanced and demanding implements with the optimum efficiency to take advantage of their increased productivity.



### EXCLUSIVE ELECTRO HYDRAULIC MULTIFUNCTION JOYSTICK

- A Lift front linkage or rear valve control +
- B Lower front linkage or rear valve control -
- C Front or rear valve control +
- D Front or rear valve control -



#### COMFORT & SAFETY

##### STANDARD

- QuadLink front axle suspension
- Mechanical active cab suspension
- Automatic Air Conditioning
- Mirrors with electric de-icing and adjustment
- Radio, Bluetooth, with integrated microphone
- Automatic air suspended, swivel seat, with longitudinal shock absorber and pneumatic lumbar

##### OPTION

- Automatic air suspended, swivel seat, with lateral suspension
- 16 LED working Lights

#### EFFICIENCY

- All controls in the ergonomic armrest with Multipad lever
- 4 electrical spool valves with electrical joystick and fingertips
- Dyna-6 Super-Eco with Automatic mode or Dyna-VT 40km/h Eco transmission
- Cruise control and Brake-to-Neutral
- Closed-centre load-sensing 110 litre/min hydraulics

#### 1,000 rpm front PTO

- Up to 8 electrical spool valves fully configurable and customizable on the Exclusive armrest
- SpeedSteer
- Integrated Front Linkage System with independent valve
- Loader ready from factory with electric Multi-function joystick
- Dyna-6 50 km/h\* Super-Eco transmission with Super Creeper (option) or Dyna-VT 50 km/h Super-Eco

#### CONNECTIVITY

- Datatronic 5 9" touchscreen with new interface for radio, phone and all tractor functions & technology
- MF TaskDoc recording all jobs' data
- ISOBUS

- MF Guide system with Advanced guidelines
- MF Section & Rate Control
- MF TaskDoc & TaskDoc Pro recording all job's data exchange
- Fieldstar 5 terminal
- MF Guide guidance ready from factory
- MF Connect telemetry

\* Depending on market/legislation

# MADE FOR SMART FARMING & CONNECTIVITY

THE NEW MF 6S RANGE HAS TAKEN SMART FARMING AND CONNECTIVITY TO NEW HEIGHTS.

The MF 6S range features the latest standard Connective Package, which comes with Real Time Information and Remote Service. What's more, it comes with a new and more intuitive Datatronic 5 interface as well as with the Fieldstar 5 terminal to control: MF Guide, MF Section and Rate Control as well as data transfer and management through MF TaskDoc and TaskDoc Pro.

“ We run our operations with the very latest technology and need to reduce inputs as well as using excellent data management facilities. ”



# DATATRONIC 5

POWERED BY FUSE® SMART FARMING SOLUTIONS



Full tractor functions management and optimisation features such as transmission, engine and hydraulics. Moreover there is the remarkable Dual Control system providing excellent control of semi-mounted ploughs by automating the furrow entry and exit. At the same time the system adjusts the plough's depth wheel in relation to the rear linkage.



The new MF E-Loader auto-control function helps to increase loading accuracy, productivity and safety. It enables operators to weigh individual fork or bucket loads. It also records the total weights of each item, load or job and these can be transferred as a simple spreadsheet. Operators can set-up and save automatic sequences for different loading cycles. MF E-Loader also provides a useful bucket shake facility.



Headland management settings – The Datatronic 5 comes as standard with the most intuitive, straightforward and easy to use automatic headland management system available in the market. It is designed to save you significant time at headlands, allowing you to concentrate on the operation in hand so that you can maximise outputs with ease.

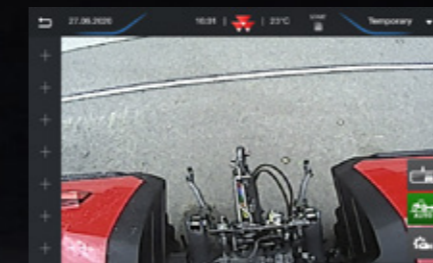

Video Mode\* (available through AGCO Parts for Efficient and Exclusive versions) – Pictures from the on-board camera can be displayed on the console screen, allowing operators to monitor complex implements or simply improve safety and efficiency when reversing.

\*image for illustration purpose only



Access to radio functions via Datatronic 5: the same as you would in a car, simply connect devices via Bluetooth, USB or aux control with the option of synchronising more than one smartphone. Memorise radio stations, receive and make calls and other functions.



ISOBUS MultiPad switch assignment – ISOBUS implements can be controlled directly using the MultiPad lever. Having all controls (tractor and implement) on the same lever is a lot more convenient than using additional displays and levers.



Memorise data and settings – Unlimited number of user settings configurations enable the system to record information during operation on area worked, fuel use, hours worked and much more.

All the settings and parameters can be stored by the Datatronic terminal, and can then be recalled to find the previous setting that was used on a tractor.



ISOBUS for total implement control – ISOBUS allows an implement manufacturer's control system to be displayed on the terminal screen, saving owners and operators time and money, with no need to install additional monitors in the cab. Simply plug the implement lead into the tractor's ISOBUS socket and the system automatically uploads the operating menus and displays on the screen.



# MADE TO KEEP YOU ON TRACK

MF GUIDE IS MASSEY FERGUSON'S FULL FEATURED, HANDS-FREE STEERING SYSTEM, CAPABLE OF DELIVERING SUB-METRE, DECIMETRE AND CENTIMETRE ACCURACY, **INCREASING THE EFFICIENCY OF YOUR FARMING OPERATIONS.**



# CHOICE OF RECEIVERS & CORRECTION SIGNALS



With the new Massey Ferguson MF Guide, there are now two different receiver systems available: NovAtel® and Trimble®. Existing Trimble® RTK infrastructures on the farm, such as NTRIP, can continue to be used. Talk to your local Massey Ferguson Dealer or Distributor to find out more.

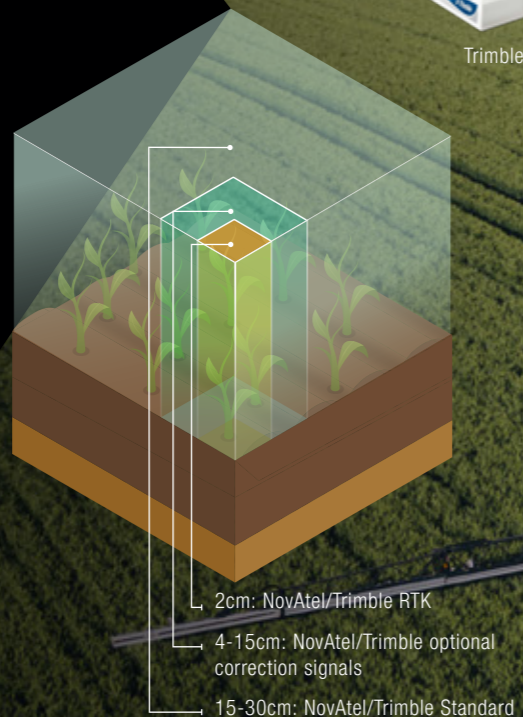

xFill™ Technology  
Should you lose your signal due to the terrain, MF Guide continues to work reliably up to 20 minutes without a correction signal thanks to Trimble®-xFill™ technology.



# EASY, FAST SET-UP WITH GO MODE FUNCTION

Starts up within 5 minutes, even for first time users. This allows the operator to begin working with auto-guidance/steering for the first time in three easy steps...



# KEY BENEFITS FOR YOU



**12% FUEL SAVING**  
Guidance systems are proven to save up to 12% fuel in field operations.

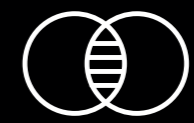

**NO OVERLAPS**  
MF Guide virtually eliminates overlaps.



**SAVINGS**  
Using MF Guide helps you save money by reducing overlaps, precision application and increasing efficiency.



**COMFORT**  
Using MF Guide helps to reduce fatigue and stress by guiding you efficiently through your working day.

# MFrate control

FUSE SYNCHRONISED

**Variable application with Variable Rate Control (VRC)**  
Data transfer with TaskDoc™ (or Pro version) now permits variable rate application, based on the needs of the soil or plants, and therefore saves operating inputs. The individual requirements for seeds, fertiliser and pesticides are shown on application maps. They are then called up during

operation and automatically executed. The big advantage: operating inputs can be defined and planned with the aid of the field database and then applied with utmost precision. For example, you can tailor chemical or fertiliser application in areas as required, lowering input cost and further enhancing yields.



# MFsection control

FUSE SYNCHRONISED

MF Section Control is the new Precision Farming solution from Massey Ferguson providing the most advanced and most efficient Section Control feature managing up to 36 sections and 5 applications. With the fully automatic Section Control for ISOBUS implements, operators can apply seeds, fertilizer or pesticides without overlapping. This prevents double treatment and areas worked outside of the field edges. With the aid of the straightforward and easy to use Section Control assistant, the operators can set the correction values for each implement, quickly and easily. The system uses the tractor's GPS system to automatically turn on and off individual sections in areas that have already been covered which automatically results in economical application and enhanced yields.



200 kg/ha

220 kg/ha

170 kg/ha

# MF TASKDOC & AGRIROUTER: NEXT MACHINE MANAGEMENT

## MFtask doc

FUSE SYNCHRONISED

Information is power, with accurate data measurement and recording enabling more precision in decision making. The new TaskDoc™ system has a place in the future of agriculture, helping farmers to become more productive through the knowledge brought by putting precision-measured data at the business owner's fingertips.

With **TaskDoc™** all jobs' data can be recorded with a minimum of effort, documented in the field record and then analysed, all in the shortest amount of time. The data is transferred via USB Stick from the Datatronic 5 terminal to the office using the ISOBUS standard TC-BAS. Data on the quantity of seeds and fertiliser applied or the fuel consumption is available immediately after the work is done.

The **TaskDoc™ Pro** version, also enables recording of the GPS position data and data transfer in real-time via mobile through the secured Agrirouter Cloud service. This makes automatic, seamless exchange with ISOXML-capable field management software and mapping possible including in MF Next Management FMIS. The data for the operating inputs that have been used are transferred and can also be monitored through the Datatronic 5 terminal while working.



# AGRIROUTER



This universal data exchange platform lets you connect machinery and your Farm Management Information System (FMIS), regardless of vendor or manufacturer. You can also determine who to exchange data with, and to what extent. Agrirouter is your ticket to the digitalization of agriculture, enabling you to retain control of your data.



Machinery Manufacturer

App Provider

Input Companies

Food Processing Industry

External Data-Exchange Platforms



Farmer

Contractor

Dealer

Adviser

External Service provider



# MADE FOR PERFORMANCE

THE PURE EXPRESSION OF CONCENTRATED POWER DENSITY & EFFICIENCY

The new MF 6S teamed up with the most mature engine SCR technology on the market, the undisputed sustainable leader in heavy duty farming operations delivering class-leading power and torque, with best-in-class total cost of ownership. The most powerful 4 cylinder tractor in the market.

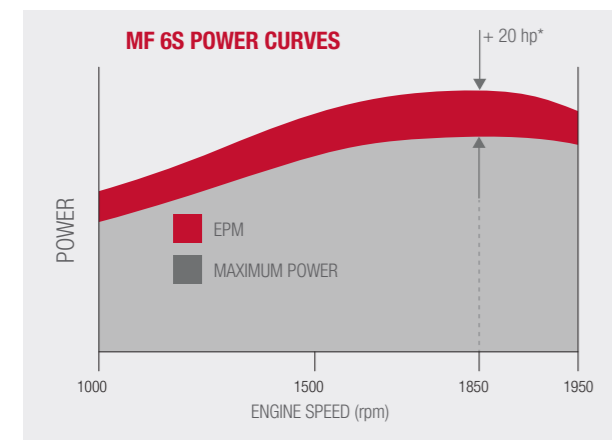
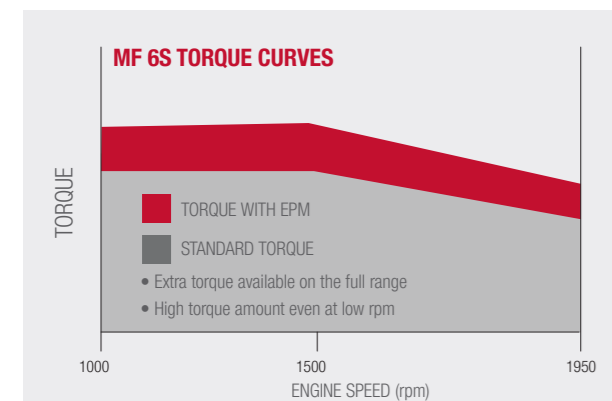

EPM available on the full range (not only at Max power)  
Constant power between Max power rpm & Max torque rpm

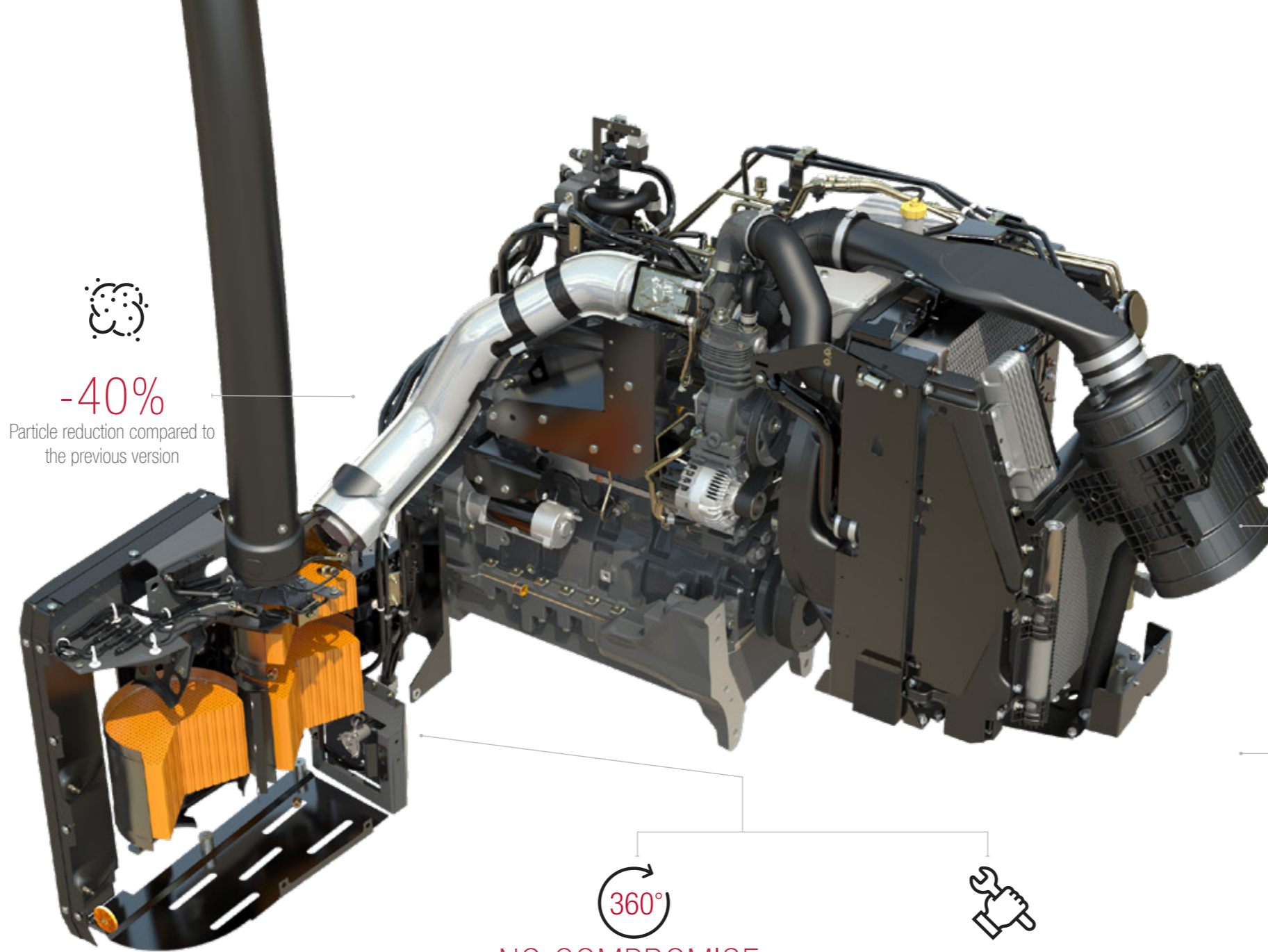

**-40%**  
Particle reduction compared to the previous version



**360°**  
**NO COMPROMISE**  
The All-in-One de-pollution system is packed up neatly under the cab contributing to keep visibility



**600h**  
Long service intervals reduce running costs

# EFFICIENT SUSTAINABILITY

The 4.9 l, 4-cylinder AGCO Power engine employs the most advanced, efficient and economical exhaust emissions system. Massey Ferguson's exclusive 'All-In-One' system is the most elegant, least intrusive method to meeting strict emission regulations that does not impede visibility and helps improve fuel economy.



**10%**  
**FUEL SAVING**  
Fuel Savings by lower engine revs



**LOW IDLE**  
Automatic low idle system cuts engine revs to save fuel and reduce noise



**SAVE MONEY**  
Thanks to the automation of valve clearance adjustment (HLA), totally maintenance free

# EPM

EPM OFFERS UP TO 20 HP MORE WHEN IT IS MOST NEEDED.

This means your MF 6S responds automatically to the load imposed on it, and adjusts fuelling accordingly to give you extra power. Designed to tackle tough transport and PTO work challenges, advanced electronic engine and transmission management makes more power automatically available under load or at speed.

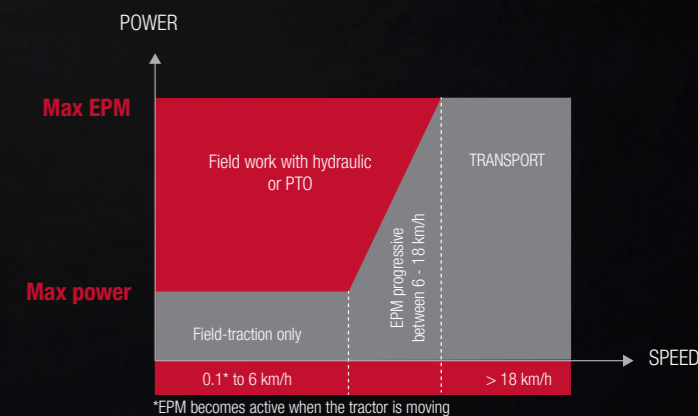

## HIGH EFFICIENCY TRANSMISSIONS

Whether your workload demands a semi-powershift or continuously variable transmission (CVT), MF 6S tractors offer exactly what you need for all applications with class-leading transmissions proven over 20 year's of continuous development.

Dyna-6 Super-Eco, with standard AutoDrive, offers six clutchless shifts in each of four ranges, which can all be controlled from the Multipad lever or T-lever control (depending on specification).

Dyna-VT Eco delivers seamless shifting for the ultimate in convenience and control in all conditions.

Both come with the unique MF Power Control lever on the left hand side of the steering column, which provides clutchless shuttling, with an adjustable response. It also shifts speeds up or down and selects neutral.

### RIGHT-HAND T-HANDLE OR MULTIPAD JOYSTICK

Simply move the T-lever transmission control forwards or backwards to change up or down through the six Dynashift ratios. To change range, simply press the selection button as you move the lever.

For further control, you can also count on the advanced Multipad lever (standard on Efficient and Exclusive): this operates the transmission as well as controlling cruise control, the rear linkage, PTO, headland management and spool valves through the integrated micro-joystick. All operations are easily to hand for greater comfort.



## POWER CONTROL LEVER

EXCLUSIVE, SIMPLE, THE UNIQUE MASSEY FERGUSON POWER CONTROL LEVER PROVIDES STRAIGHTFORWARD THREE-IN-ONE OPERATION.



### YOU CAN:

- shuttle between forward /reverse
- shift speeds and ranges: up and down
- de-clutch
- select neutral

LEAVING YOUR RIGHT HAND FREE TO OPERATE AN IMPLEMENT ON THE FRONT LINKAGE OR ANY IMPLEMENT HYDRAULICS.

# DYNA-6

PERFORMANCE, REFINED.

The ultimate semi-powershift transmission



Dyna-6 Super-Eco offers six powershift steps in four ranges for **ease of operation in the field and on the road**. A total of 24 speeds in both directions means there's a match for virtually every operation, with top transport speeds of either 40 km/h or 50 km/h\* achieved at low engine speeds.

Delivering class-leading **dynamic performance and reliability**, the semi-powershift transmission provides six Dynashift ratios, perfectly spaced in four ranges and changed without using the clutch pedal.

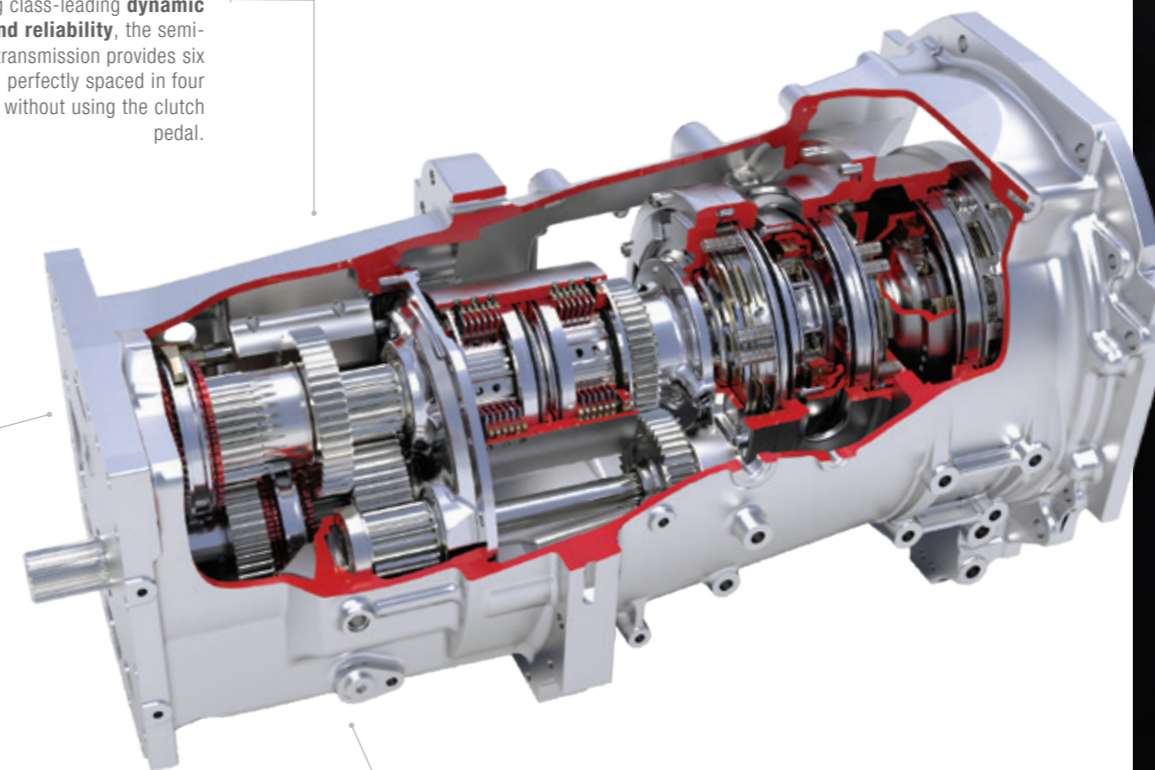

**Automatic mode** is standard on all MF 6S tractors with Dyna-6 Super-Eco transmissions. This advanced control automatically selects the correct ratio to suit the engine load and prevailing conditions.

Automatic mode's standard SuperEco feature helps cut costs, with maximum speed achieved at a very low engine speed to save fuel (40km/h @ 1,500rpm, 50km/h\* @ 1,800rpm, depending on tyres).

◀ **Dyna-6 Super-Eco** provides six Dynashift changes in each range, offering 24 forward and 24 reverse speeds, with an excellent overlap and a total of nine speeds in the Field Working range.

\*Depending on market/legislation

DYNA-6 TRANSMISSION



## DYNA-6 BENEFITS AT A GLANCE

- ▶ 0.08 to 40km/h or 50 km/h\* with Supercreeper
- ▶ Maximum productivity with 24 forward and 24 reverse speeds, all changed without using the clutch
- ▶ Power Control lever offers three functions in one – forward/reverse shuttle, declutch and speed shifting
- ▶ Nine speeds in the Field Working Range
- ▶ Pedal mode Automatic mode with Automatic setting
- ▶ Brake-to-Neutral, with direct activation, disengages transmission with braking
- ▶ Supercreeper speeds as option (48x48)
- ▶ Super-Eco as standard



24x24  
Speeds



# DYNA-VT TRANSMISSION

THE SMOOTHEST POWER DELIVERY, THE ULTIMATE IN PRODUCTIVITY.

Dyna-VT continuously variable transmissions are now equipped with a new Automatic mode. Simply activated with a switch on the armrest, auto mode allows the operator to adjust forward speed with the Multipad lever or the foot pedal, while the engine speed is automatically regulated according to the load and speed. The hand throttle now also sets a lower engine speed limit – with rpm never dropping below this limit.

The new Super-Eco version of the Dyna-VT reduces fuel consumption by achieving 40 km/h at just 1,450 rpm.



## DYNA-VT BENEFITS AT A GLANCE

- ▶ Stepless transmission brings complete operator's comfort and optimum fuel efficiency at all times
- ▶ Simple, infinite speed control, from 0.03 speeds to 40 km/h or 50 km/h\* available with 40 km/h Super-Eco or 50 km/h\* Eco
- ▶ The choice of two speed ranges optimises torque for different applications
- ▶ Lever, pedal control means operator can choose his preferred mode
- ▶ 'Supervisor' maximises output under varying loads
- ▶ Automatic mode maintains set travel speed by automatically adjusting engine speed according to load
- ▶ Shuttle and Pedal aggressiveness adjustment with Brake-to-Neutral feature

\*Depending on market/legislation



**INFINITE**  
Speeds from 0.03 km/h to 40 km/h or 50 km/h\*



**HIGH COMFORT**  
Stepless transmission.

# ULTIMATE COMFORT. STEPLESS TRANSMISSION.

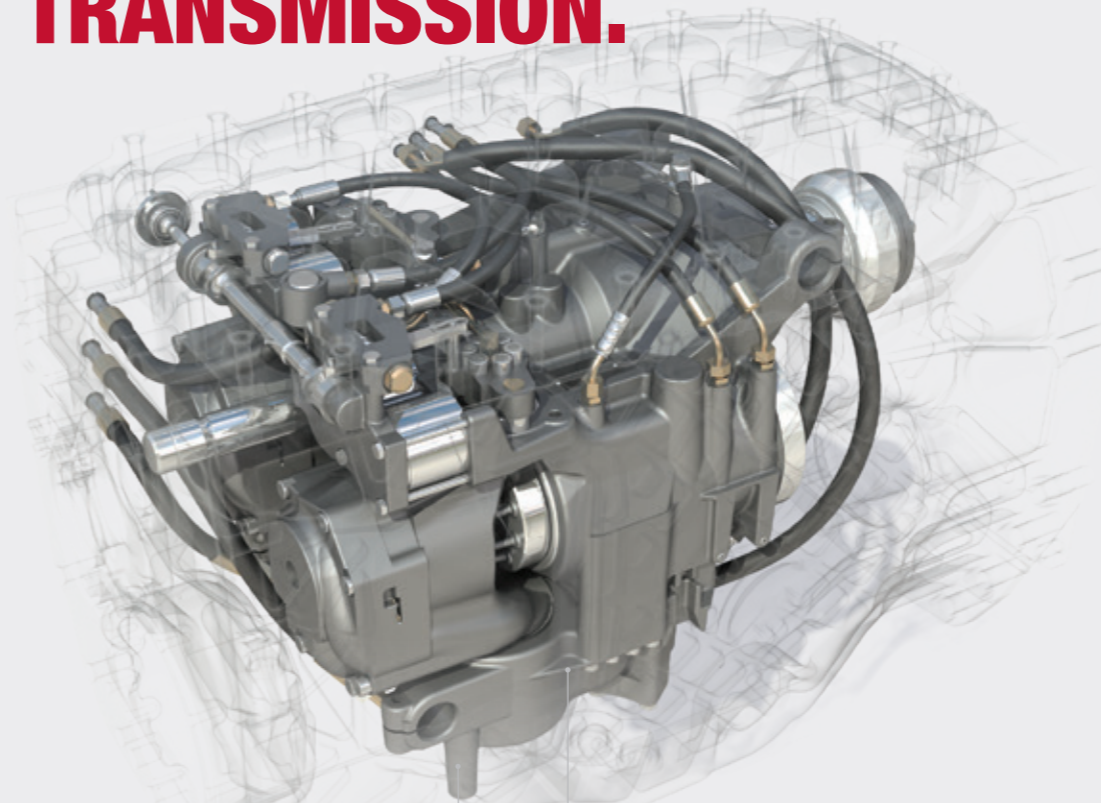

The 'Supervisor' is on continuous stand-by and activates when engine speed falls under load. The benefit of the 'Supervisor' is that even when the load on the engine is increased and engine speed drops, the transmission will automatically reduce forward speed to maintain total power, whether in PTO applications, field work or transportation. When used in conjunction with C1 and C2, which set a specified forward speed, the tractor will then operate at maximum output as load fluctuates as well as automatically adjusting the tractor back to the required speed.

The original Dyna-VT transmission is a true testament to precision engineering; guaranteed **productivity, complete operator comfort and optimum fuel efficiency** at all times. Further, consistent enhancements such as Automatic Mode make it the most intuitive CVT transmission on the market.

## AUTOMATIC MODE

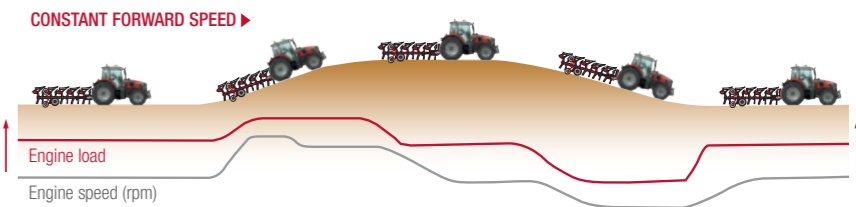

▲ The highly-regarded Dyna-VT continuously variable transmission now has a new automatic mode. This allows operators to use the Multipad lever or foot pedal to alter forward speed, while automatically setting the optimum engine speed according to the load and speed. As well as delivering smoother operation, it also improves fuel efficiency.

As the load (red line) changes according to varying conditions, the Dyna-VT automatically responds by adjusting the engine speed (grey line) to maintain the set forward speed. This optimises performance, saves fuel and reduces noise.

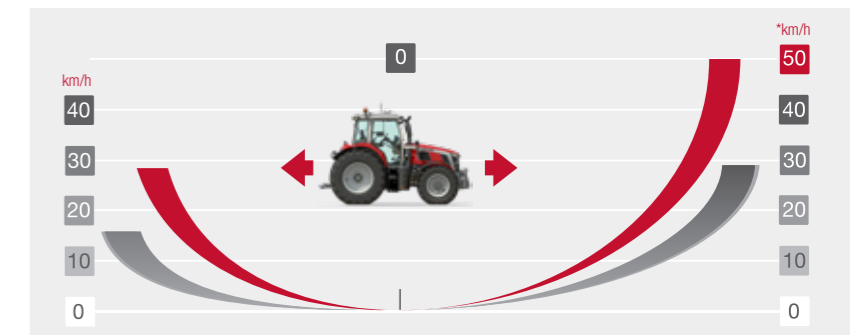

▲ **STEPLESS TRANSMISSION**  
Dyna-VT is amazingly simple to operate and works extremely well in differing conditions. There's no shifting of gears, no jolts and no breaks in traction or power.

Simple, infinite speed control, from creeper speeds to 50 km/h\*.

\*Depending on market legislation

## MADE FOR MANOEUVRABILITY & TRACTION

With its sculpted chassis design and smart, slim bonnet the MF 6S Series turns tightly and safely. The chassis design improves handling on the road and provides perfect weight distribution for excellent traction and maximum soil protection in the field.

### PERFECT WHEELBASE FOR THE PERFECT POWER AND SOIL PRESERVATION.

An increasing number of farmers seeking tractors in the 135 to 200 hp bracket are realising the benefit of a four-cylinder tractor. A lighter footprint (half a ton less than a comparable six-cylinder), better manoeuvrability and extra payload possibilities are just some of the ways in which, for some operators, a four-cylinder machine can make more sense than a six-cylinder tractor in this bracket.

The MF 6S blends all the benefits of a four-cylinder machine – compact dimensions, low overall weight, good manoeuvrability – with the pulling, pushing and lifting power to match a comparable six-cylinder tractor with a maximum lift capacity of up to 9,600 kg plus an outstanding towing capacity and increased Gross Vehicle Weight up to 12,500 kg to handle heavy implements with ease.

“I need maximum soil preservation and minimum compaction for cultivation, drilling and ongoing applications.”

2.67 m

4.75m  
turning radius\*

#### FOUR-WHEEL DRIVE AND DIFFERENTIAL LOCK

Automated functions on the differential lock and 4WD systems include:

- ▶ Automatic disengagement of 4WD and differential lock above 14 km/h
- ▶ Automatic differential lock disengagement when a rear linkage-mounted implement is raised (and re-engagement when lowered) and when either one or both of the brake pedals are pressed (and re-engagement when released)
- ▶ Automatic 4WD engagement when both brake pedals are depressed, when the differential lock is engaged or the handbrake applied
- ▶ Automatic differential lock activation linked to wheels' turning angle, depending on version

#### FRONT AXLE SUSPENSION ▶

Improved comfort and safety for transport applications and greater traction is delivered by the innovative front suspension option, compatible with all equipment: loader, front linkage, front PTO... The simple design produces superior ride comfort, turning angle and offers the full angle of oscillation as well as maximising ground clearance.

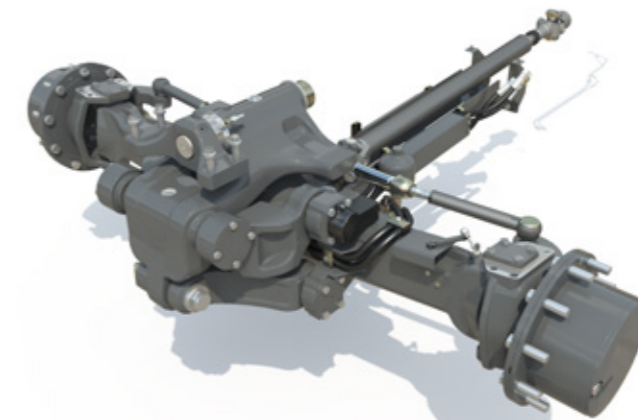

\*Track 1.9 m with 420/85R28 front tyres

#### MANOEUVRABILITY

The tightest turning circle on a 200hp tractor!

Whether in the field or around the yard, the tight turning circle benefits of the short wheelbase and curved front frame design soon become clear. Even on tractors specified with a front linkage, the turning circle is not compromised. MF 6S tractors can turn in a circle of just 9.5m in diameter. That means faster headland turns, quicker loader work and better productivity and safety.

▼ **SPEEDSTEER** reduces operator effort and provides faster turns - maximising your time in the cab. It enables the operator to adjust the steering ratio and select the number of turns of the steering wheel required for a given amount of steering angle turns.





## THE NEW DIMENSION IN TRACTION

### TRACTOR POWER MEANS NOTHING IF IT CANNOT BE TRANSFERRED TO WHERE IT MATTERS: THE GROUND.

The MF 6S has the ideal weight distribution (45% front and 55% rear) and can comfortably tackle many applications associated with six-cylinder tractors, yet with greater manoeuvrability and a lighter footprint. A wide choice of tyre dimensions and ballasting options available for the MF 6S offer improved traction, with less soil compaction for keener operating costs and higher crop yields.



#### Michelin VF650/60R42 rear tyres

Unique standards of ground traction are set by the Michelin VF650/60R42 rear tyres, available on MF 6S.165 and MF 6S.180 as an option. These 42" rear tyres guarantee maximum versatility (from ploughing to transport applications thanks to VF Technology) and power to the ground with minimum soil compaction (thanks to the large footprint).

- ▶ Greater care of the land\*
- ▶ Greater fuel savings\*
- ▶ Improved service life\*
- ▶ Greater load-carrying capacity\*
- ▶ Time-saving\*
- ▶ Better road handling\*

\* Assuming compliance with Michelin recommendations, compared with tyres using conventional technology

### SELECTING THE CORRECT BALLASTS & TYRES: BENEFITS AT A GLANCE

- ▶ More power to the ground
- ▶ Ultimate traction capabilities
- ▶ Limited soil compaction to boost yields whilst maintaining soil health for the next generation
- ▶ Improved fuel economy



With its compact dimensions, special chassis design and 2.67 m wheelbase the MF 6S Series are highly manoeuvrable, versatile and strong workhorses.

An optimum weight distribution and a perfect power-to-weight ratio combine to provide superb stability and handling while their inherent light weight helps to protect the soil as well as improve economy.

With an increased gross vehicle weight up to 12,500 kg, they also have the power to excel in heavier draft operations, with the addition of smart monobloc ballast boosting traction. Its compact design has little effect on the overall tractor length, maintaining the excellent manoeuvrability and preserving the ground clearance without interfering with the front lights.

Monobloc ballast can be mounted to the rear or front linkages or it can be fitted directly to the tractor's front frame.

MADE TO GET ANY  
**JOB DONE**  
 OUTSTANDING OPERATION  
 AND PERFORMANCE TO  
 TACKLE ANY TASK

With its compact dimensions, 2.67 m wheelbase and turning radius of just 4.75 m the MF 6S Series are not only manoeuvrable, but also high performance tractors, combining the highest productivity with optimum economy.

Light and nimble for loader operations, the MF 6S Series also offers the strength, hydraulic power and lift capacity for heavy duty fieldwork.

Offering the performance of a larger, heavier six-cylinder, but from a compact four-cylinder, the MF 6S Series is also packed with performance-enhancing features, able to lift up to 9,600 kg on the rear linkage and power the most modern implements with its high flow hydraulics.



“ The key to effective operations is to select a tractor that can easily handle modern equipment and operate them at their full potential in a wide range of agricultural applications. ”



# MADE TO GET ANY JOB DONE

UP TO 190 L/MIN

Depending on your needs you'll be able to equip your MF 6S tractor with the hydraulic flow that you need to power any of the most demanding implements at low engine speeds and maintain high output with economy.

HYDRAULIC FLOW COMPATIBILITY (l/min)	OC:	LS:	LS:	LS:
	100	110	150	190
MF 6S Dyna-6 (Essential)	●	○	-	-
MF 6S Dyna-6 (Efficient & Exclusive)	-	●	○	-
MF 6S Dyna-VT	-	●	-	○

● Standard specification ○ Optional - Not available  
OC= Open Centre LS= Load Sensing



Up to **2** front spool valves and free return.



Up to **3,200 KG** lift capacity. Heavy duty Integrated Front Linkage System (IFLS) is available as an option and is designed to match the front suspension.



**1,000 RPM** front PTO is available. Combined with the front linkage, it allows a wide range of additional implements to be powered: reducing passes and improving efficiency. Benefit from real time savings – more than doubling output when mowing grass.

Rear remote valve control on fender



**ISOBUS** socket connects compatible implements.



Up to **4 PTO** speeds available as an option: 540, 540 ECO, 1,000 or 1,000 ECO. For lighter duty duties, '540 Eco' or '1,000 Eco' PTO speeds are achieved at about 1,550 engine rpm, further improving fuel economy and helping to reduce in-cab noise levels.



Up to **9,600 KG** lift capacity from heavy duty rear linkage with Ultimate Draft Control. MF's digital ELC system gives the highest standards of draft control with more accurate depth settings and better ground contour following. The result is more weight transfer, better traction, less wheel slip, reduced tyre wear and reduced fuel consumption whilst still maintaining greater output.



Up to **5** rear spool valves and free return with decompression lever for easy uncoupling of implements.

# POWER BEYOND

BUILT INTO THE CCLS SPOOL BLOCK IS A **POWER BEYOND FACILITY** that via additional flow and return pipes provides oil flow directly from the pump, enabling additional remote spool valves to be connected.

# THE NEW WAY TO OPERATE YOUR TRACTOR-LOADER

Whatever your MF 6S Series tractor's specification it can come complete from the factory equipped with a MF loader, which forms an integral part of the machine and is designed for maximum manoeuvrability and easy maintenance access.

These all combine to make loader work, easier, safer and much more comfortable for operators.



## MF FL SERIES LOADERS

	m	Non self levelling		Self levelling					
		MF FL.4125	MF FL.4227	MF FL.4121	MF FL.4124	MF FL.4220	MF FL.4323	MF FL.4327	MF FL.4621
Maximum lift height - measured at pivot pin	m	4.06	4.25	4.06	4.06	4.2	4.25	4.25	4.55
Maximum dump angle at maximum height	deg	56	57	57	57	54	57	57	53
Maximum rollback angle at ground	deg	48	48	48	48	49	48	48	52
Lift capacity to maximum height - 800 mm pivot pin	kg	1,300	1,590	1,980	2,300	1,930	2,140	2,470	1,980
Lift capacity, 1.5 m height - at pivot pin	kg	1,870	2,110	2,100	2,440	2,020	2,350	2,700	2,110
Breakout force - 800 mm from pivot pin	kg	2,070	2,270	2,290	2,640	2,160	2,470	2,840	2,230
Rollback force at ground level - 800 mm from pivot pin	kg	3,420	4,030	3,370	3,910	3,420	3,400	4,540	4,000
Digging depth	mm	160	160	160	160	170	160	160	200

\*\*\* FL.4121/FL.4124/FL.4220 loader must be specified with extended bearing boxes if tractor is specified with front linkage



The unique Multifunction joystick option makes it easy to control the loader, also providing another shuttle option, as well as the ability to adjust the tractor speed. Grabs and other implements are also easily operated thanks to proportional control of the third spool valve, while tipping or crowding an implement at the same time.

## LOADER OPERATION

Joystick main functions:

- A. Lift
- B. Lower
- C. Fill
- D. Dump
- E. Close
- F. Open

## COMBINED FUNCTIONS:

- A/C. Lift and fill
- A/D. Lift and dump
- B/C. Lower and fill
- B/D. Lower and dump
- A/E. Lift and close grab
- A/D/F. Lift and open grab



## TRACTOR/LOADER COMBINATION HIGHLIGHTS

- ▶ Fully integrated MF FL loader now available factory-fitted to deliver ultimate performance
- ▶ Multifunction joystick option also changes direction and speed, providing total control
- ▶ Proportional control of a third spool valve enables operators to open/close a grab and tip or crowd an implement at the same time
- ▶ Highest visibility thanks to the smart profiled design of the bonnet, the dashboard and the narrow exhaust pipe
- ▶ Unrestricted manoeuvrability and access for maintenance
- ▶ Visio Roof option with Falling Object Protection (FOPS)
- ▶ Excellent manoeuvrability including tight turning angles, SpeedSteer
- ▶ New Bucket Shake function on Multifunction joystick
- ▶ New quick coupling system reduces pressure losses at high flows, quicker loader movement and saves fuel
- ▶ Hydraulic implement locking can be activated via the SIS
- ▶ New, standard Engine Speed Automation on the SIS menu allows operators to increase the engine speed according to the action on the joystick
- ▶ To further improve loading performance a range of output and comfort enhancing features are available including high flow hydraulics and the Brake-to-Neutral function, which also disengages drive when the brakes are applied
- ▶ New MF E-Loader available as an option to optimize the use of the loader and to measure loading tasks from the Datatronic 5 touchscreen.



MADE TO  
**MAXIMISE  
UPTIME**  
ENHANCED TRACTOR  
OWNERSHIP EXPERIENCE &  
COMPLETE PEACE OF MIND

“Uptime is critical for my business efficiency”



CONNECTED ANYWHERE. ANY TIME.



GREATER UP-TIME, OPTIMISED MAINTENANCE AND SMARTER SERVICES WITH MF CONNECT.

OWNER, DEALER AND TRACTOR ARE 100% CONNECTED!

MF Connect is a fleet monitoring system, that allows customers to keep a close eye on their Massey Ferguson machines.

Viewing machinery operations and equipment operating parameters in virtually real time on their mobile phone, tablet or desktop computer has never been easier.

This enables owners and managers to manage operations more effectively, helping to improve operating efficiency with remote diagnostics, ensuring optimum uptime.



FIX YOUR COSTS AND GUARANTEE OPTIMUM PERFORMANCE FOR YOUR MF 6S WITH MF CARE.

MF Care Service and extended warranty contracts are flexible to suit your payment and operating hours requirements. Regular servicing provides preventive maintenance – picking up any faults before they become a problem, which helps reduce downtime. A full dealer service history using genuine AGCO Parts will also increase the residual value of the machine.

- ▶ Support maximum residual value of your tractor
- ▶ Flexible terms and long-term price packages
- ▶ Available up to 12 months from registration
- ▶ Experienced MF technicians available for on or off-site servicing

	SILVER	GOLD
DETAILS	REGULAR MAINTENANCE CONTRACTS The Service Package includes all prescribed maintenance work on the basis of fixed prices.	REPAIR CONTRACTS Extended warranty contracts which offer security against repair costs (except wear). Tariffs with or without excess available as an option.
MACHINE TYPE	All	All
REGULAR MAINTENANCE*	YES	YES
REPAIR COST	NO	YES
DEDUCTIBLE	NO	Option: €0, €190, €490

\*the list price stated by AGCO refers solely to the extended warranty and doesn't include maintenance.

MASSEY FERGUSON OFFERS A COMPREHENSIVE AND EFFICIENT RANGE OF SERVICES



YOUR COURTESY FLEET

'MF Always Running, Your Courtesy Fleet'\* provides you with a temporary replacement tractor to ensure you can continue working with minimum interruption to maximise uptime while your tractor is being serviced or repaired.

We know that you can't stop until the job is done and MF Always Running ensures the need for maintenance or repairs won't stop your operations. As an MF tractor owner you will be quickly back up and running with a replacement tractor – but not just any tractor, it will be the latest model equipped to the specifications you need to get the job done.

\* Please contact your local Massey Ferguson Dealer to check availability in your area. Terms and conditions apply that might vary according to the market or country. Available in the UK, Ireland, France, Germany, Italy, Spain, Poland, Norway and Denmark.

MASSEY FERGUSON 24/7 CUSTOMER HOTLINE

Your Massey Ferguson dealers are always by your side to make sure your Massey Ferguson Machine is Always Running.

In case you need any support on your machine simply call your certified service centre 24/7 on the emergency hotline. Service available in Denmark, France, Germany, Italy, Norway, Poland, Spain, UK and Ireland.



24/7 HOTLINE +800 8700 365 7



## PARTS & SERVICE

### IT'S ALL ABOUT A LIFETIME OF SUPPORT

Buying, owning and maintaining farm machinery can be complex, so having absolute peace of mind that you have great back-up and support is a hugely important consideration. As a Massey Ferguson customer you are assured of personalised, responsive and friendly support from our network of expert dealers who truly understand your business.

There's no cut-off time for Parts and Service because a machine may be out of service. We're available to you throughout your ownership of your Massey Ferguson machine.

We take great pride and responsibility in every machine we sell and we make it our mission to keep your machinery running reliably, every time you turn the key.



“I want daily maintenance to be quick and easy so I can spend more time with my friends.”

### THE MF 6S HAS BEEN DESIGNED TO PROVIDE FAST, STRAIGHTFORWARD, EASY AND COST-EFFECTIVE ROUTINE MAINTENANCE.

We have combined practicality with style to ensure daily maintenance is speedy, straightforward and simple, taking the stress out of maintaining your tractor, getting you to the field earlier for greater productivity and giving you some free time. With a Massey Ferguson MF 6S Series tractor, time spent in the yard preparing for the day ahead is kept to a minimum.



Engine air filter is easy to access and clean.



Front axle and slim waist bonnet design make oil dipstick and filter access easy.

### OPTIONS & ACCESSORIES

Today's farming demands machinery that is optimised to your business. Designed to tailor your Massey Ferguson machine to your needs, we offer a wide range of options and accessories – from loaders, weights, extra spool valves and hydraulic flowrates all the way through to auto-guidance technology. For your ultimate comfort there are seat upgrades, sound systems, drinks coolers and much more.

Everything we offer has been scrutinised by our engineers from all perspectives – optimum compatibility with your machine, safety, durability and performance. You'll get expert service from your Massey Ferguson dealer who has all the necessary installation tools and knowledge at their fingertips.



Easy access to remove the cab air filter for cleaning.



Cooling package is easily accessible to make cleaning faster and easier.



# MFservices

## ALWAYS BY YOUR SIDE TO INCREASE YOUR PROFIT AND EFFICIENCY

WELCOME TO MF SERVICES – EVERYTHING YOU NEED TO SUPPORT THE OPERATION OF YOUR MF 6S TRACTOR.

Accessible and adaptable, MF Services will help you control running costs, budgeting and business planning - ensuring each machine's operating hour is a success and giving you the freedom to focus fully on the core business of farming.

This comprehensive suite of service-related-products makes it easier than ever to own and operate Massey Ferguson farm equipment.

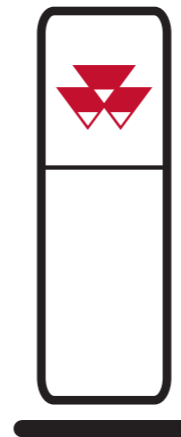

### MASSEY FERGUSON DEALER NETWORK

Your MF Dealer represents the best farm machinery expertise in your area. You can always turn to your dealer to receive the best service from sales, maintenance, repair and spare parts to the purchase of a new piece of equipment.

MORE THAN 4,700 SERVICE & REPAIR POINTS WORLDWIDE



### MASSEY FERGUSON GENUINE PARTS

REPRESENTS THE BEST GUARANTEE OF SAFEGUARDING THE VALUE OF YOUR NEW MF 6S OVER TIME, PROTECTING IT FROM UNPLANNED DOWNTIME.

Choose from an extensive range of accessories including lubricants, AdBlue, care kits, cab accessories and much more. All accessories are available for purchase exclusively from your MF Dealer.

Using the smartphone app "AGCO Parts Books to go", you can find MF spare parts quickly and easily and order them directly. The app is available for download in the App Store and in the Google Play Store. Your personal access data is available from your MF Dealer.



### AGCO FINANCE

PROVIDES THE PERFECT FINANCING ARRANGEMENT FOR YOUR BUSINESS.

AGCO Finance is the integrated financial services arm of Massey Ferguson offering tailor-made solutions to your own farm, which includes Leasing, Loan facilities, Hire purchase, Full service packages and Contract hire including the financing of MF Care extended warranty contracts.



### MASSEY FERGUSON COLLECTION

NOW YOU CAN LOOK AS STYLISH AS YOUR MASSEY FERGUSON.

Looking for a cap to match your MF 6S, or a stylish and durable overall to keep working? We have an exclusive range of high quality products to suit you, your farming activity, your family and your lifestyle.

To find out what we have available please login into our online Shop:

[Shop.MasseyFerguson.Com](http://Shop.MasseyFerguson.Com)

For the above support packages, country terms and conditions apply. Please note all packages may not be available in all markets.

Please check with your local MF Dealer/Distributor.



## TECHNICAL SPECIFICATIONS

Engine	MF 6S 135	MF 6S 145	MF 6S 155	MF 6S 165	MF 6S 180
Engine Type	AGCO POWER with "All-in-One" Stage V technology				
Number of cylinders/Number of valves/Capacity	No. /No./cm3 4 / 4 / 4,900				
Aspiration	Electronic wastegate turbo and intercooler				
Injection type	Common rail				
Fan type - Transmission Dyna-6 & Dyna-VT	Vistronic				
Maximum power	135 (100)	145 (107)	155 (114)	165 (121)	180 (132)
Engine rpm at maximum power	rpm 1,950				
Maximum torque @ 1,500rpm	648	691	745	790	800
Maximum torque @ 1,500rpm with EPM	650	700	750	800	840
Maximum power with EPM	150 (111)	160 (117)	175 (129)	185 (136)	200 (148)
Fuel tank capacity	Litres 280				
AdBlue® tank capacity	Litres 35				
<b>Dyna-6 Transmission</b>					
Number of gears	Fwd x Rev 24 x 24				
Min. speed @ 1,400rpm	km/h 1.09				
40 SuperEco km/h at engine speed with max. tyre dimension	rpm 1,500 (with 650/65 R38)				
50 km/h* SuperEco at engine speed with max. tyre dimension	rpm 1,800 (with 650/65 R38)				
<b>Dyna-VT Transmission</b>					
Type	Stepless, Continuously variable transmission				
Field speed range	km/h Forward: 0.03-28km/h - reverse: 0.03-16km/h				
Road speed range	km/h Forward: 0.03-40km/h - reverse: 0.03 to 28km/h / Forward: 0.03-50km/h - reverse: 0.03 to 28km/h*				
<b>Rear Linkage and hydraulics</b>					
Lower links type	Cat 3				
Maximum lift capacity, at link end	kg 7,100 (Dyna-6) / 9,600 (Dyna-VT)	7,100 or 8,100 (Dyna-6) / 9,600 (Dyna-VT)		8,100 (Dyna-6) / 9,600 (Dyna-VT)	
Standard hydraulic system	Open centre 100l/min (Essential); Close centre 110l/min (Efficient & Exclusive)			Close centre 110l/min	
Optional hydraulic system	Closed centre 110 or 150 or 190 l/min			Close centre 150 or 190 l/min	
Maximum pressure	Bars 200				
Maximum number of rear spool valves	4/5 (Dyna-VT)				

### KEY

- ⊕ ISO TR14396
- Not available
- \* Depending on market legislation

Every effort has been made to ensure that the information contained in this publication is as accurate and current as possible. However, inaccuracies, errors or omissions may occur and details of the specifications may be changed at any time without notice. Therefore, all specifications should be confirmed with your Massey Ferguson Dealer or Distributor prior to any purchase.

Rear Power Take-Off
Engine speed at 540/1000 rpm
540/540 Eco/1000/1000 Eco
540/540 Eco/1000/1000 Eco Dyna-VT
Shaft diameter
<b>Independant Front linkage and Front Power Take-Off</b>
Lower links type
Maximum lift capacity, at link end
Maximum number of front spool valves
Engine speed at 1,000 front PTO speed
<b>Wheels and Tyres</b>
<b>(Full range available. Please consult your Dealer)</b>
Front
Rear
Optional rear tyres
<b>Weights</b>
<b>(May vary depending on configuration. Please consult your Dealer)</b>
Minimum weight / average weight / maximum weight excluding fuel and accessories
Maximum gross vehicle weight up to*

	MF 6S 135	MF 6S 145	MF 6S 155	MF 6S 165	MF 6S 180
rpm	1,980 / 2,030				
rpm	1,980 / 1,530 / 2,030 / 1,570				
rpm	1,870 / 1,500 / 1,900 / 1,530				
Inches	1 3/8" 6 & 21 splines				
Cat	Cat 3				
kg	3,200				
	2				
	1,920				
	420/85 R28		480/70 R28		
	520/85 R38		580/70 R38		
	650/60 R42 - Wide choice available, contact your local Massey Ferguson dealer				
kg	5,300 / 6,500 / 8,000		5,500 / 6,700 / 8,200		
kg	12,500				

## Dimensions

		Dyna-6	Dyna-VT
A – Wheelbase	m	2.67	
B – Overall length from front weight frame to rear linkage arms	mm	4,715	
B – Overall length from front linkage to rear linkage arms	mm	5,400	
C – Height at centre of rear axle to top of cab	mm	2,110	2,144
D – Maximum height	mm	2,985	3,019

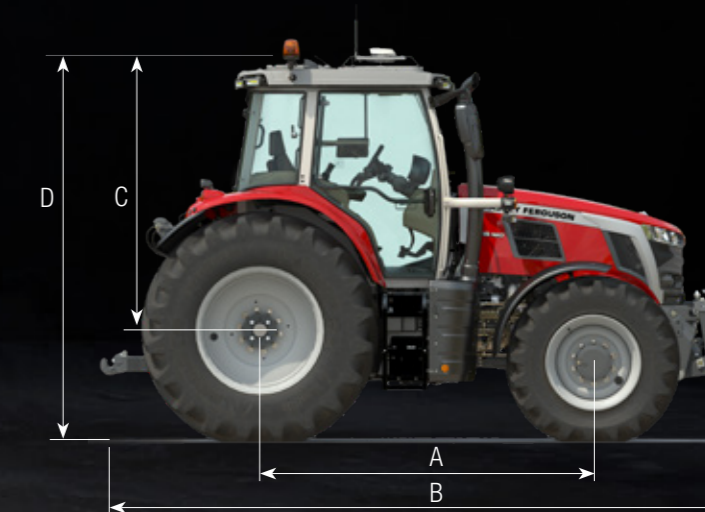



**A NEW ERA  
FOR STRAIGHTFORWARD AND  
DEPENDABLE CONCENTRATED  
PERFORMANCE**



[www.MasseyFerguson.co.uk](http://www.MasseyFerguson.co.uk)

[www.facebook.com/masseyfergusonUK](https://www.facebook.com/masseyfergusonUK)  
[Twitter.com/MF\\_EAME](https://twitter.com/MF_EAME)  
[Instagram.com/MasseyFergusonGlobal](https://www.instagram.com/MasseyFergusonGlobal)  
[www.YouTube.com/MasseyFergusonGlobal](https://www.YouTube.com/MasseyFergusonGlobal)



**MASSEY FERGUSON**® is a worldwide brand of AGCO.  
© AGCO Corporation | A-A-17302 | English



**MASSEY FERGUSON**

BORN TO **FARM**